

SERVICE BULLETINS

10/5/11 No service bulletins

Verify All Part Numbers Are Current

Version	Parts No	Short Description
ALL	BN44-00342B	Power PCB Function & IR PCB
ALL	BN96-13226B	
ALL	BN94-03446Q	Main PCB
ALL	BN07-00834A	Panel
ALL	BN81-04415A	T-CON PCB
ALL	BN96-10689A	Stand Guide Neck
ALL	BN96-12769A	Rear Cover
ALL	BN96-14033A	Front Cover
ALL	BN96-12760A	Stand Guide
ALL	BN96-12764E	Stand Base
ALL	BN40-00163A	Tuner
ALL	BN96-12838A	Speaker
ALL	BN96-12723E	LVDS Cable
ALL	3903-000467	Power Cord
ALL	BN59-01041A	Remote
ALL	BN63-01798B	Cleaning Cloth

HELP : 1-888-751-4086;1-866-894-0637 (FE)

GSPN

<http://gspn3.samsungcspportal.com>

PLUS ONE

<http://my.plus1solutions.net/clientPortals/samsung>

HOT TIPS

Power On Problems: (see page 2)

Video Problems: (see pages 3,4)

TIP: After replacing Main/Panel picture is upside down.

Fix: Test Mode/Mirror Option/Toggle

FIRMWARE

10/18/2010

Firmware for Valencia 128M and X4 Model-. Version : 1010.0 (Valencia 128M), 1005.0 (X4) -. Folder Name: T-VAL5AUSC & T-MSX6AUSC

This firmware will prevent below problems..USB Power Overload' message pops up even USB port is not connected

. HDMI 2 looks activated when HDMI 1 port is connected

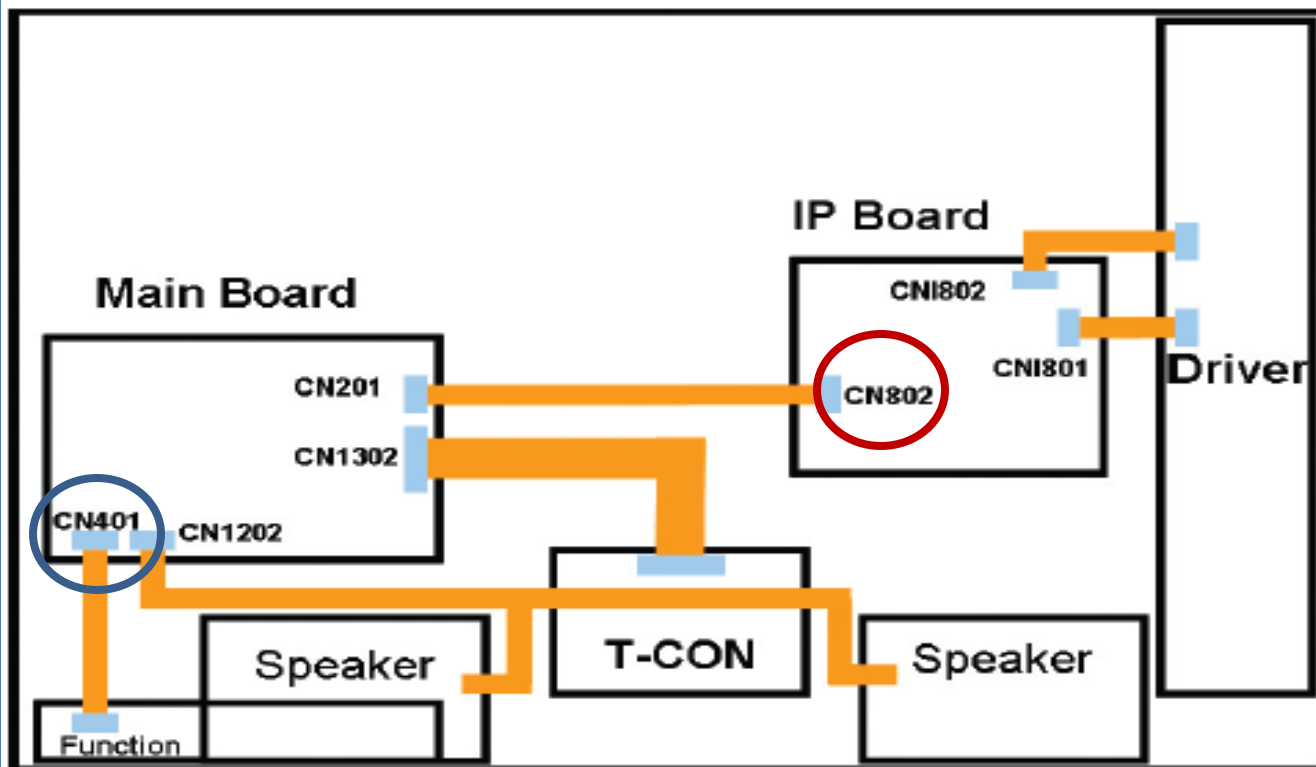

CN201

CN201(to Power board)

1	B12V_PW	10	GND
2	A5V_PW	11	GND
3	B12V_PW	12	H_OUT
4	A5V_PW	13	B13V_PW
5	B5V_PW	14	PWM_DIMMING_OUT
6	B5V_PW	15	B13V_PW
7	B5V_PW	16	B5V_PW
8	GND	17	B13V_PW
9	GND	18	IP_DET

CN401(to Function/IR)

1	IR	6	KEY_INPUT1
2	GND	7	KEY_INPUT2
3	A3.3V_PW	8	LED_STB
4	MSCL_A5V	9	LED_CNTR
5	MSDA_A5V	10	A3.3V_PW

Power On Sequence (approximate Voltages)

1. **Standby Voltages:** CN201-4 (5V)
2. **Power On** CN201-2 (0 – 3V)
3. **Low Voltage Supplies On** CN201-1,3,5,7,13,15,17 (Volts Listed on CN802)
4. **Back Light On** CN201-16 (0-3V, delayed)
5. **Back Light Confirm** CNI802- (FB1 & FB2)
6. **Dimming Signal** CN201-14 (1V–4V approx)

To Force Backlight On without Main Board :

1. Remove Power Cord
2. Remove CN802
3. Plug Power Cord In.
4. Backlight should be on immediately.

TROUBLESHOOTING VIDEO PROBLEMS

1. Verify Video Operation

- a. Customer Picture Test (models available)
- b. "Display" (If display is OK source is suspected)
- c. Substitute with known good Source (external DVD or Signal Generator)

2. Using Test Patterns in Service Mode

- ENTER SERVICE MODE -

1. Select an active source signal. (HDMI preferred)
Test Pattern may rely on signal source to appear.

Customer Remote

2. Power off
3. Mute, 182, Power

Service Remote

2. Power On
3. Info, Factory

2010 Models with FRC 120Hz/240Hz

LCD Signal Path for Troubleshooting

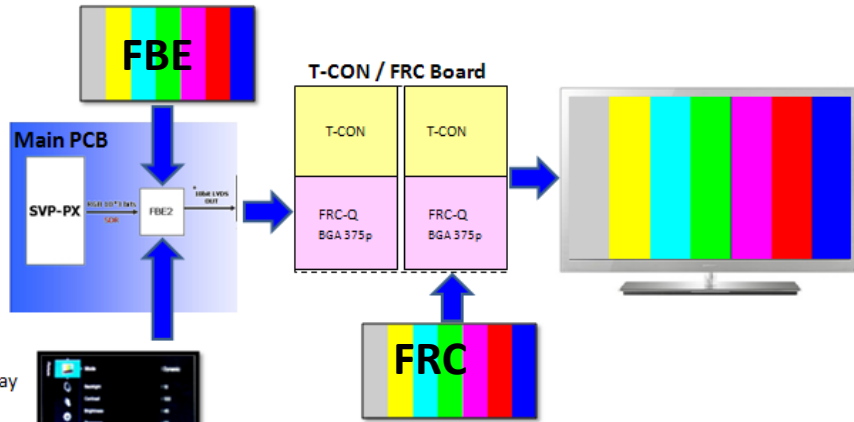

1. Check OSD & Customer Picture Test.
2. Access SVC Mode (with source signal)
3. Activate **FBE** Test Patterns & Verify.
4. Activate **FRC** Test Patterns & Verify.

T-Con Troubleshooting

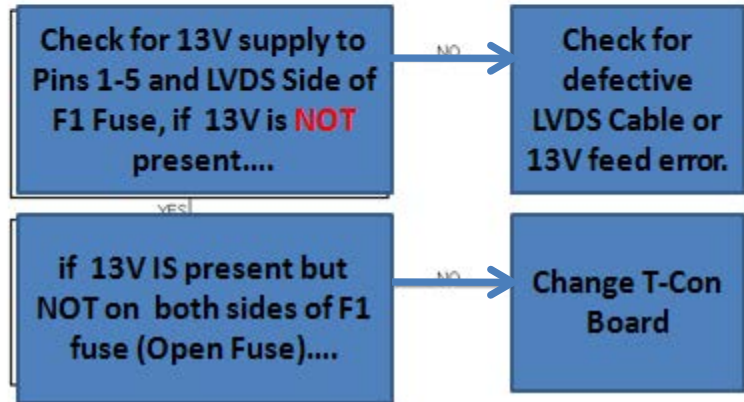
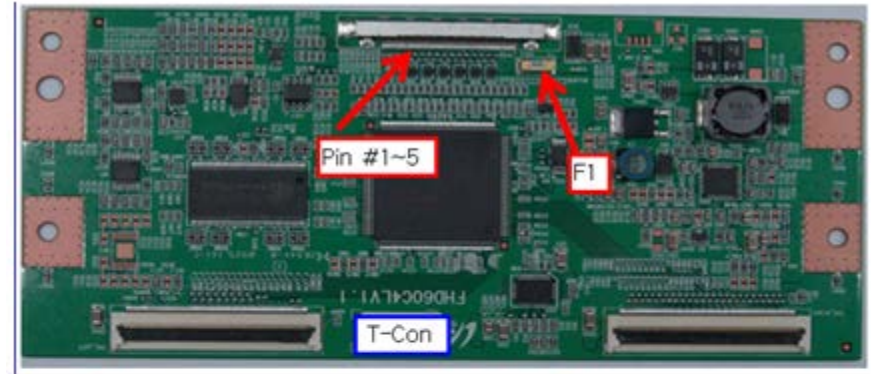



ON SCREEN FAILURE EXAMPLES:

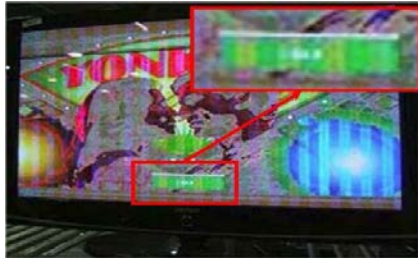

If Picture & Display errors
Defective Main Board, LVDS,
or T-CON



Green lines or a green screen
defective main board , LVDS , or
T-CON.



Original Image



Image on Screen

Pixelization can be caused by the main board
but is more commonly a source error

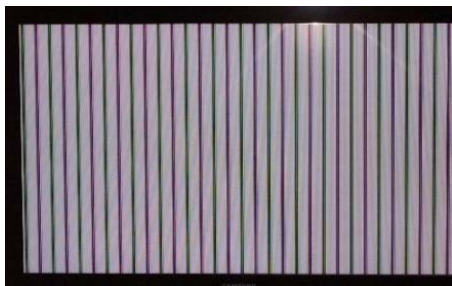

Vertical or Horizontal Lines :Defective
Panel likely but also T-CON, LVDS, or Main
Board. Use Test Patterns in Factory Service
Mode to determine error)

ALIGNMENTS:

1. Check/Set Option Bytes:

- Using the Customer Remote
1. Turn the power off and set to stand-by mode
 2. Press the remote buttons in this order; POWER OFF-MUTE-1-8-2-POWER ON to turn the set on.
 3. The set turns on and enters service mode. This may take approximately 20 seconds.
 4. Press the Power button to exit and store data in memory.
- If you fail to enter service mode, repeat steps 1 and 2 above.
 5. Initial SERVICE MODE DISPLAY State

Project	PB5G	PB5G	PB5G
Model	B550	B550	B550
Model Code	PN6B550T2FXZA	PN6B550T2FXZA	PN6B550T2FXZA
No.	ITEMS		
1	Factory Reset	-	-
2	Type	50FSpl4	63FMeK1
3	Model	PB550	PB550
4	TUNER	ALPS	ALPS
5	Region	US	US
6	DDR	SAMSUNG	SAMSUNG
7	Light Effect	Off	Off
8	Inch	50"	63"
9	Exhibition Mode	Off	Off

Option Bytes

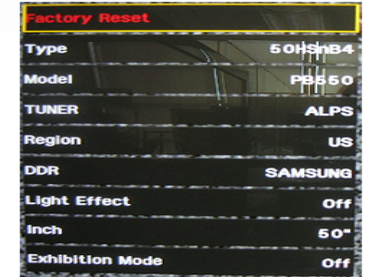

Model Code	Front Color					
		Type	Model	Tuner	Region	DDR
LN55C610N1FXZA	T-C-BLK	55L1UF0C	LC610	SEMCO	US	-

2. Check/Perform Firmware Upgrade for all repairs.

3. Perform reset in Service Mode & Plug and Play if Main board is replaced.

SPECIAL NOTES:

Inform customer of reset of all
Settings if Main Board or Panel is replaced.